



Fall Equinox Issue, Y.R. XLIX

September 20, 2011 c.e.

Volume 27, Issue 6

Editor's Note

It appears that the Facebook pages are accelerating (Reformed Druids of North America and Reformed Druids Gorsedd) and in a sense, this newsletter is becoming a scrapbook of what goes on there, the RDNAtalk website and whatever I pick up from newsfeeds and submissions. Things change, we change too! This *Druid Inquirer* still provides a form of historical record and a moment to pause and reflect over the last six weeks, and perhaps to look ahead a season or two.

Deadline for Samhain submissions is October 15 to mikerdna@hotmail.com



TABLE OF CONTENTS

News of the Groves

Druids in the Media

New Blogs, Facebook Pages, Webpages

Mini Movie Reviews

* Stonehenge Apocalypse, Circle of Iron

* Troll Hunter, Dragon Slayer

* Brave, 5th Sacred Thing

* Thor, Thor&Loki, Thor Hammer of the Gods

* The Strange Show

* WoW "Druid" videos (3)

Mini Book Reviews

* The Story of Halloween, When Dinosaurs Die

* Weaving Word Wisdom, Raising Witches

Podcasts- Northern Druid, Tree Hugger

Artists & Speakers - Owl Moon, John M. Greer, Penny Young,

Humorous Druid Art – Humon's Mother Gaia

Desperate Druids – Rebooted and recast!

The Great Druid Joke Book, Vol. 1 (10 pg)

CRAFT: Silver Clay

NEWS: Sun is Suspected Source of Global Warming

NEWS: Sun is Smiling!

NEWS: Slavic Deity Found in River

NEWS: Prehistoric Irish Landscape Beneath Ocean

AD: Desecration – What Part of Sacred Don't You Understand?

Please also see our Facebook websites:

Reformed Druids Gorsedd

Reformed Druids of North America (RDNA)

Yahogroups:

RDNAtalk

RDGtalk

And the YouTube Channel:

www.youtube.com/ReformedDruids



One Year Later, in Memoriam

Brother Isaac Bonewits, K.U.T.M. (Keep up the mischief). Been a year now since he skeddaddled on us to take care of matters in the afterworlds. Has anyone been getting any updates on his pursuits across the veil? I wouldn't put it past him to release some more books and records. I had so hoped to be arguing with him another 30 or 40 years.



Sacred Groves

NEWS OF THE GROVES

Monument Grove: News from DC

Today's lesson with the kid: the light in the sky is the sun over on the horizon, it makes the sky pink, we call this dawn, your mother's name means dawn in Japanese, that is why I love the dawn so much, and because I love her you are here, and so we are walking in the morning. Kid: "I like dawn"

Sincerely

Mike the Fool
mikerdna@hotmail.com

Three Stones Protogrove: News from Nevada

Greetings to the Reform from S.Nevada!

As the desert begins the cooling of the season, the junipers shed some of its mistletoe and sage is being harvested, and bundles for smudges, the Three Stones protogrove is growing in new numbers of those wishing to be Druids, and our online and offline training schedules are about to flourish into a new rebirth! We are taking this time to 'review' the RDNA material with each who come, and preserve what we can, and grow from and with it!

Our guardian willow has grown greatly from the small tree planted a little time ago, and now overshadows the Altar from the northside and makes much shade in the hot climate we call home! The Three Stones protogrove is now working, when time permits, with other non related Groves, and having small gatherings to 'bond in the spirit of Druidry'... 'yea, one way amongst many'

Peace!

Brid the Preceptor,
Three Stones Protogrove
Three.stones.protogrove@gmail.com

Port Huron Protogrove: News from Southern Michigan

how are ya? This is kirk from the 'Spirit of the Earth Mother' grove aka Port Huron protogrove in michigan. We have come out of hibernation and are active again and reforming!! Please update our status so any druids in michigan will know we are here, thanks for all your help Mike, hope all is well

Hunger3377@yahoo.com
kirkhofer@yahoo.com

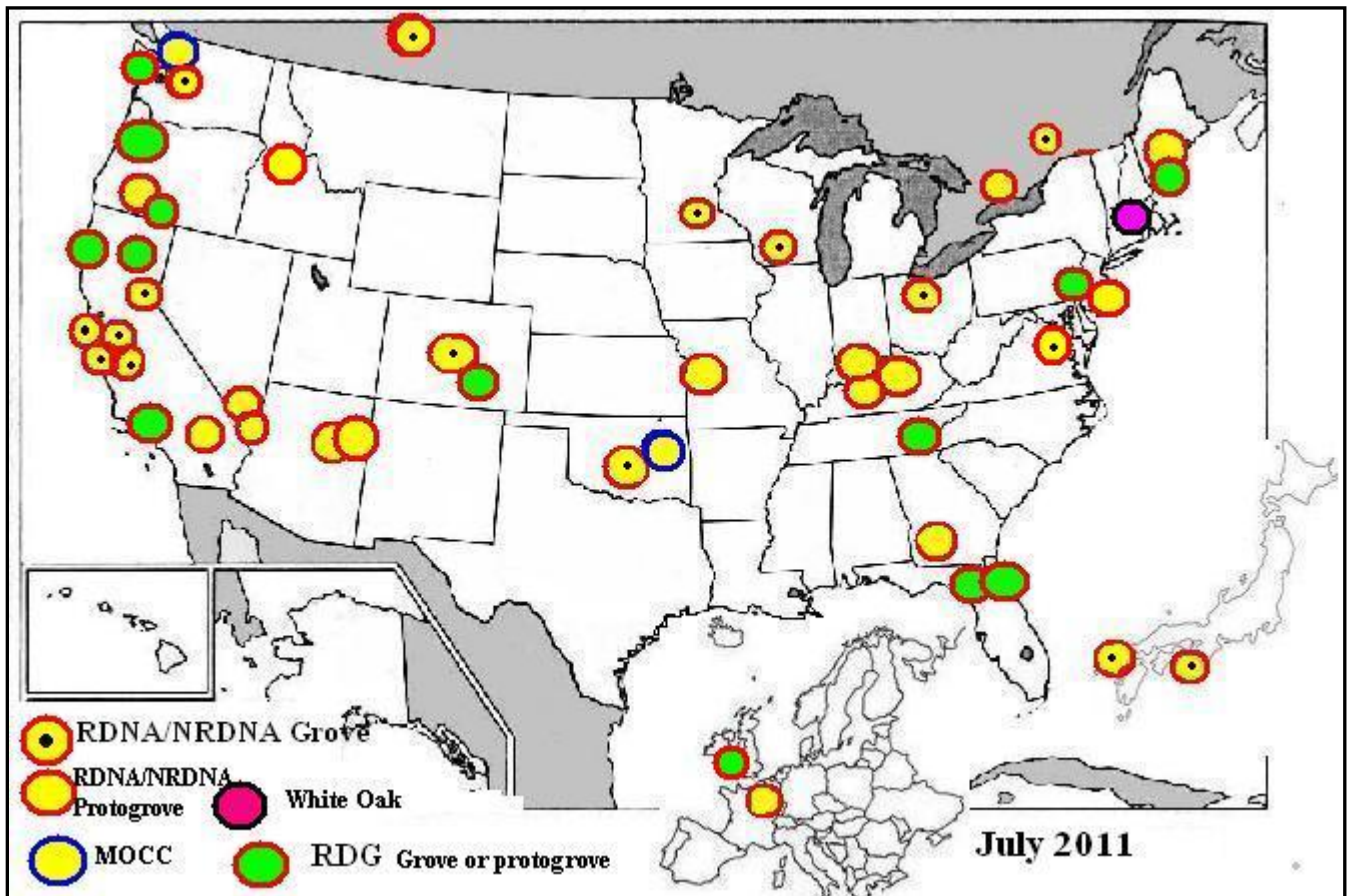

Where the Druids Are: Perhaps.

<http://rdna.info/wheretrove.html>

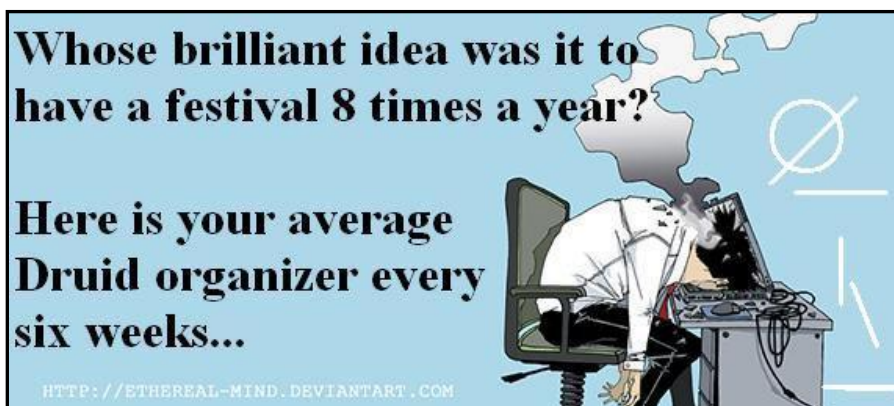



DRUIDS IN THE MEDIA

Things I've seen, that you might like. –Mike

NEW BLOGS



<http://rdnapontiacqc.blogspot.com/>

La Clariere du Pontiac website of Sebastien in Quebec
Bilingual postings.



The Green Book of Dalon ap Landu: Please learn to read
dalonaplandu.blogspot.com

Thoughts, ideas, musings and opinions as channeled by one of his Priestesses.

Strong Language Note



Pretty Good essay, my definitions would be a bit different, but I think many Reformed Druids are uneasy with having to belong to a religion just to be spiritual or mystic, which can also happen outside religious participation.

[What Atheists Believe Too](http://roguepriest.net)

roguepriest.net

This is a guest post by Trent Fowler. Atheism is not really an assertion of anything. Contrary to what its name might imply, it is not a confident proclamation that there is no God, no gods, and...

FACEBOOK PAGES



First Intergalactic Temple (Reformed) of the Druids
(Space Balls Movie 1987)

<http://www.facebook.com/pages/The-First-Intergalactic-Temple-Reformed-of-Druids/260646330630968?sk=info>

She's a Druish princess!

That's funny, she doesn't look Druish!

WEB PAGES



[The Big Religion Comparison Chart: Compare World Religions - ReligionFacts](http://www.religionfacts.com)

www.religionfacts.com

The Big Religion Comparison Chart is a comparison chart of religions that compares the origins, beliefs, practices, and texts of world religions, small religions, ancient cults and new religious movements.

http://www.religionfacts.com/big_religion_chart.htm for a big chart, unfortunately, no Druidism, yet.

MINI MOVIE REVIEWS



STONEHENGE APOCALYPSE (2010) (Rated: 3 of 5 acorns)

<http://youtu.be/kQRC1MRFC4A>

I know what you're thinking. Bad, awful, British egocentric belief that the beginning and end of the world will be in Britain. Yes. All that. But it wasn't very badly done. I wish there had been more involvement (read: any) with the Druids, but your basic – ancient civilization left a weapon and all our science can't fix it (or a bulldozer) so we need to rely on a loner crazy scientist whiz-kid.

“When a disgraced scientist discovers unusual spikes in the Earth's electromagnetic field emanating from Stonehenge, it is up to him to warn the world of a potential cataclysm.”



Circle of Iron - Movie Trailer - Blue Underground (Rated: 4 of 5 Acorns)

GREAT MOVIE.

One lesson I drew from this movie (one among many) is that the great religious books are mirrors for the majority of their readers. Good and bad people will find justification for what they want to believe, and will ignore what disturbs their assumptions. When a monkey looks in a mirror, he sees a monkey, when the Buddha looks in, he sees the Buddha.

“The Adventure Epic Written By Bruce Lee - His Dream Project He Would Never Live To See! At the height of his international fame, the legendary Bruce Lee.”



Troll Hunter Blu-ray (Rated: 3 of 5 Acorns)

<http://youtu.be/TLEo7H9tqSM>

Troll Hunter Blu-ray (Trolljegeren) (2010): Starring Otto Jespersen, Hans Morten Hansen and Tomas Alf Larsen.

A group of students investigates a series of mysterious bear killings, but learns that there are much more dangerous things going on. They start to follow...

One word..... "TRRRROOOLLLLLLLLLL!".... and "RUUUUUN" and something clever about 3 billy goats. I saw it in theatre, give it 3 acorns out of 5, but it was the finest Norwegian film I have seen, in um, 10 years at least. Lengthy walking and driving scenes, circumspect folks, fuzzy footage, lots of stomping and running in the woods, all things I look for in a movie. TRRRROOOLLLLLLLLL!



Dragonslayer trailer (Rated: 5 of 5 Acorns)

<http://youtu.be/At8UUrDptn8>

My second attempt at video editing of this kind, clips from the movie Dragonslayer to the music from Naruto Shippuuden. I hope you like it

Dragonslayer (1981)

Romance, battles, magic, evil henchmen, deep community divide over virgin sacrifices to dragons, and probably one of the most memorable Dragons in cinematic history. It all fits together. Worth another viewing.



Brave Trailer - Official 2012 trailer from Disney Pixar | HD

Brave features Merida, an aspiring archer and impulsive daughter of royalty. Merida makes an irresponsible decision that inadvertently unleashes danger and forces her to launch into action to set events right. Coming soon this fall/winter.



The Fifth Sacred Thing

www.kickstarter.com

The Fifth Sacred Thing is set in 2048, where an ecotopian San Francisco defends itself from invaders using nonviolence and magic.

Starhawk is trying to use kickstarter to generate funding to do a film adaptation of her novel.

THUNDER THEMED MOVIES

I kind of went crazy on August 8th (I am Patriarch of the 8th Order) which coincided with the movie Thor release in theaters. Here's a bit of what came out around then.



The 8th Order's new primary mascot: the Taranis-saurus Rex! For you vegetarians, you may use the alternative, "Brontosaurus", which means "Thunder Lizard". Taranis accepts nothing but the biggest and best!



Thor - Trailer (OFFICIAL) (Rated: 4 of 5 Acorns)

Watch the first trailer for Thor, in theaters May 6, 2011. <http://thor.marvel.com/> Directed by Kenneth Branagh, the epic adventure "Thor" spans the Marvel Un...

Taranis doesn't mind sharing the limelight(ning) with his better known incarnations. ; Thor, Zeus, Perkunis, Electro, etc. Hope you saw this movie this summer?

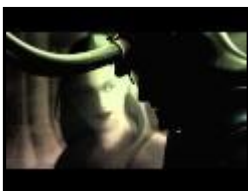

Thor & Loki: Blood Brothers Animated Series Official Trailer (Rated: 3 of 5 Acorns)

Marvel Knights Animation is proud to announce Thor & Loki: Blood Brothers, an all-new four-episode series debuting on iTunes, Xbox LIVE, and PlayStation®Netw...

A bit dark webseries, I thought, and those horns for Loki are just plain impractical, that's why bad-guys always mess things up, too dramatic!



Thor: Hammer of the Gods (part1/9) (Rated: 2 of 5 Acorns)

www.youtube.com

Thor along with his friends travels to mysterious island seeking glory and fame. Upon arriving they encounter strange creatures and they start searching the ...

As usual, SciFi Channel can't do anything well, but they can do it quickly!

WEB SERIES



[The Strange Show - The Strange Show, Series 01 - Episode 06](#) (Rated: 4 of 5 Acorns)
This week's show features the ancient cult of paganism, alive and flourishing in modern Scotland and Margaret Bennett and Mark O'Dowd investigate Edinburgh's...

There are 6 half-hour episodes of this scottish documentary series on the paranormal and strange, with lovely accents. This one talks about a few well known Beltane sites in modern Scotland. Generally positive and curious, good viewing fun and some interesting commentary. Makes me want to go back. Others in series focus on Rev. Kirk & fairies, ghosts, etc.

MISCELLANEOUS VIDEOS



[UK deems Druidry a religion](#)

gdata.youtube.com

Charity authority gives Druidry religion and charity status in UK



[Laura Shigihara - Blood Elf Druids \(Original Song\)](#) (Rated: 4 of 5 Acorns)

You can find the song here:<http://laurashigihara.bandcamp.com/track/blood-elf-druids>

Song written and produced by Laura Shigihara:<http://shigi.wordpress.co/...>

Sorry, but this song has really hooked me, or at least the music & visuals, so here it comes at you again! I want to ride turtles and dance by waterfalls in between slaying ogres!

On second thought, I really hope that my daughter grows up to be like the singer, Laura. Such a sweetie! If you like her song, check out her Plants vs. Zombie videogame Anthem! http://youtu.be/0N1_0SUGIDQ



Now, myself, I was all over D&D back in the 1980s, but this is just getting ridiculous, not that all online RPGs are going gaga over Druids. Have you folks seen a "spike" in newcomers being inspired by WoW and other games? I think it is less so than D&D, because, well, there isn't much religion in WoW, you kill and cast spells more so than pursue a lifestyle, don't you think?

[Crank Dat Druid Boy](#) (Rated: 3 of 5 Acorns)

<http://www.myspace.com/druidboyz> !! Crank Dat Druid Boy Druid song

(Chorus) Druid Boy up in this Hoe, Watch me switch forms, watch me go.

Watch me switch to ...

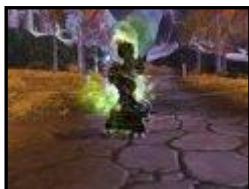

[Druid Anthem](#) (Rated: 2 of 5 Acorns)

If you wanna download my songs, head over to my soundclick, the link's

below:<http://www.soundclick.com/bands/default.cfm?bandID=1077014&content=music> This p...

[Chris Brown ft. Lil' Wayne - I Am A Druid](#) (Rated: 2 of 5 Acorns)

I'd like to thank everyone who helped out in the making of this video, Magetroll and Gardenparty of the two who definitely made this possible, but my fellow ...

<http://www.youtube.com/watch?v=UWHEcIbhDiw>

Here is a modern Canadian version of Mike's Taliesin post

Delightful machinima video from Second Life with Taliesin's Battle of the Trees

http://www.youtube.com/watch?v=t0gduIjXOU4&feature=player_embedded#t=0s

MINI BOOK REVIEWS



[Pastor Salary](#) (Rated: 4 of 5 Acorns)

www.my-pastor.com

Developing an adequate pastor salary package is a challenge for every local church. But a little planning can make the clergy compensation process much less painful

An interesting article on considering the cost of a minister's salary, often the largest aspect of a church's budget. Most Druid groves I know have under 10 members, so supporting a full-time priest is out of the question for many groves, even a part-time share or "circuit druid" program. ADF has come the closest, but have few full-paid staff/priests (if any). Many ministers/priest need "a day job" of course.



The Story of Halloween

by Carol Greene (Rated: 5 of 5 Acorns)

A good run through of the various layers of the holiday for ages 3 to 12. Talks about variants with Druids, Romans (Pomona), early Christian, English, Irish feast items of the season, the famine bringing them to America, the shift from turnips to pumpkins for jack o lanterns and the story of Jack, American expansion of costuming, the recent shift from house visits to organized parties, UNICEF boxes, party games and a few very ideas and spooky riddles.

Format: Each page of text with facing whimsical illustration, reminiscent of Nightmare before Halloween.
\$17

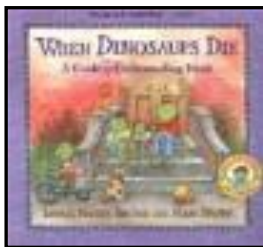

[When Dinosaurs Die: A Guide to Understanding Death \(Dino Life Guides for Families\)](#) (Rated 5 of 5 Acorns)

The authors explain in simple language the feelings people may have regarding the death of a loved one and the ways to honor the memory of someone who has died.

Marc Brown, the author, is well known for the "Arthur" PBS series of an aardvark who likes to read. This is simply an amazing book that exceeded my expectations. It wasn't so much a story of one particular person (good for ages 3-8) but a conversation-provoker book of 26 illustrated pages that approached death from many angles. More in comment section.



[Raising Witches](#) (Rated: 5 of 5 Acorns)

This is the first book (2002) that gives parents the means to teach their children Wicca in a more formal fashion. Featuring a Wiccan curriculum for each of the five age groups from infancy to young adulthood, O'Gaea shows parents how to effectively weave Wicca into a child's natural progression of ...

I have a 2 & 4 year old, and I am reading through available books on nature-centered child-rearing, which tend to be Wicca-oriented (not that I care too much), and also working on the 1995 classic by Ceisir Smith, "The Pagan Family" which I also like. "Raising Witches" is smooth and well-transitioned, based on their raising a child in Arizona for 18 years, some theory, some counseling, lots of ideas.



[Ogam: Weaving Word Wisdom, an Ebook by Immanion Press](#)

www.smashwords.com

Stemming from years of experience and a Celtic Reconstructionist background, Erynn writes with authority and impeccable scholarship. However, this is no dry, boring read. Her writing style invites the reader to join her as she explains the history of ogam (including some of the misconceptions)

<http://www.smashwords.com/books/view/88696>

Ogam: Weaving Word Wisdom

Ebook By [Immanion Press](#)

Rating: Not yet rated.

Published: Sep. 13, 2011

Category: [Non-Fiction](#) » [New Age](#) » [Magic](#)

Words: 108738 (approximate)

Language: [English](#)

Ebook Short Description

Stemming from years of experience and a Celtic Reconstructionist background, Erynn writes with authority and impeccable scholarship. However, this is no dry, boring read. Her writing style invites the reader to join her as she explains the history of ogam (including some of the misconceptions and mistakes commonly found in modern sources)

Extended Description

Stemming from years of experience and a Celtic Reconstructionist background, Erynn writes with authority and impeccable scholarship. However, this is no dry, boring read. Her writing style invites the reader to join her as she explains the history of ogam (including some of the misconceptions and mistakes commonly found in modern sources), introduces us to each one of the ogam and their origins, and offers ideas for divination layouts. There's plenty more to the magic of ogam than divination, though, and Ogam: Weaving Word Wisdom makes it quite clear that if you thought you knew everything about ogam--you're in for a big surprise!

[My First Thoughts without Reading It](#): Another book on Ogham, for those who can't get enough.

PODCASTS



Northern Druid Podcasts by Scott Schumacher, Minnesota
<http://www.northerndruid.net/northern-druid-podcast-5/>
scott@northerndruid.net

[A Druid Pilgrimage to Carleton College](#)

Published by [Scott](#) at 1:04 am under [Druidry, Memories and Moments](#)

If you are part of the [Reformed Druids of North America \(RDNA\)](#), and/or any of its offshoots and related branches, you're probably aware that "The Reform" started in a small college in Minnesota in the 60's. Back in 1963, students at [Carleton College](#) in

Northfield, Minnesota started the Reformed Druid movement as a protest against forced attendance at religious services by the college. What started as a simple protest grew many legs, and now there are thousands of Reformed Druids, Groves, Proto-groves, and related organizations.

The moral here – be careful when organizing a simple protest!

I traveled to Carleton College last week to do a solitary mini-pilgrimage to a few of the Druid sites where it all began. [You can see photos on my Flickr site from my visit here.](#) Incidentally, if you've followed my blog, you know that I used to live in Northfield, Minnesota for a time before I began this journey into Druidry. There is a more formal [Full Pilgrimage that was published in The Druid Inquirer](#) recently. While I only did a portion of the pilgrimage, it's worth the read as it gives some good background into the places I visited! Many thanks goes out to all of the Carleton Druids for starting quite a movement!

<http://www.flickr.com/photos/holisticgeek/sets/72157627359556616/>

Carleton College in Northfield, MN is where the Reformed Druids began in 1963 as a protest against forced attendance at religious services. Almost 50 years later, Reformed Druidry has spread to all parts of North America - branching into several orders and organizations, and thousands of Druids belonging to "the Reform". I undertook a mini-vigil to Carleton College on August 4, 2011 to revisit part of this rich heritage.



[We Are An Intrinsic Part Of Nature, Not Separate From Anything Else: Buddhism & The Environment](#)

www.treehugger.com

photo: Joe Stump/Creative Commons The following post is part of an ongoing series of posts briefly outlining how the world's major religions have traditionally viewed the environment and are putting those beliefs into practice today. For many TreeHugger readers

MIKE: One of the ongoing series of posts outlining how the world's major religions marry their beliefs and the environment

ARTISTS



Owl Moon

www.seawitchartist.com

Owl Moon was inspired by my Crow Moon painting, a Witch friend asked me to paint it for her.

Bye George Rix

'The Thunderbird Invoked' (RIGHT)

A modern child Witch (or one of the 'little people'?) has summoned the North American Thunderbird to Ireland's unique Burren landscape, sheltering from the force of the storm it came with under the lee of Poul nabrone Dolmen. That her medieval forbears in Witchcraft could not have known of this native American legend reflects Wicca as an old religion in the new age.



RDNA POETS AND SPEAKERS



[John Michael Greer: Nature Spirituality and the Future of Society](#)

Location: Davies Memorial Unitarian Universalist Church, Alexandria, VA

Time: 8:00PM Saturday, October 8th

AODA Archdruid, an RDNA priest, author, speaker, scholar, wise man, coming to virginia next month. Anyone planning to attend with me?

[Penny Leyson Young](#)

I just want to say as a newbie to this group and indeed to the pagan community itself, how very sad it is to see another pagan group that i belong to on here is set to be archived due to lack of activity.

I'm am from Swansea, Wales and now live in Canada, i just cant believe how bad the pagan networking is in North America. Granted i'm new to this community and have been extremely fortunate to find a few local like minded people, who have excepted me but as a newbie i find this extremely discouraging , however i do appreciate all the time, effort that people do put in. I haven't mentioned or commented on anything in this group because i don't feel qualified or knowledgeable enough to do so, but thank you anyway for trying to create a group of interest, and i for one am still interested.

[Penny Leyson Young](#)

Come Sit By My Hearth

Come sit by my hearth, warm your soul, by kindness of deeds that people show. Feel the warmth, gesture and smile, take a load off for a while.

Come sit by my hearth, feed your soul, watch the glowing embers, dance as coal.

Come sit by my hearth, let your spirits rise, share your load deep, it would be wise.

Come sit by my hearth, kindled with joy, warm yourself, wont you, rest a wee while.

Come sit by my hearth, and share with me, the burden in life that afflicts thee.

Come sit by my hearth, the embers dance, your darkest worries float through the trance.

Come sit by my hearth, let worries fade in night. Today is a new day harken the light.

[Penny Leyson Young](#)

Oh The Sunshine Feeling

Oh the sunshine feeling of finally coming home. The excitement and the fire of burning desire. To delve into the imagination, the world of the unknown and the know. The guide that guides me and inspires to go deeper and to darker places, so that my light can filter and grown, like sunlight dapples through the leaves of a tree. To learn pebble by pebble, and be washed up on the shore where the elements meet. Oh the sunshine feeling rises in me again, washing over me like a wave. Cleansing. Passing on the lessons learnt so that i may journey again and finally come home to the sunshine feeling.



DRUID

When in doubt, ask a tree.

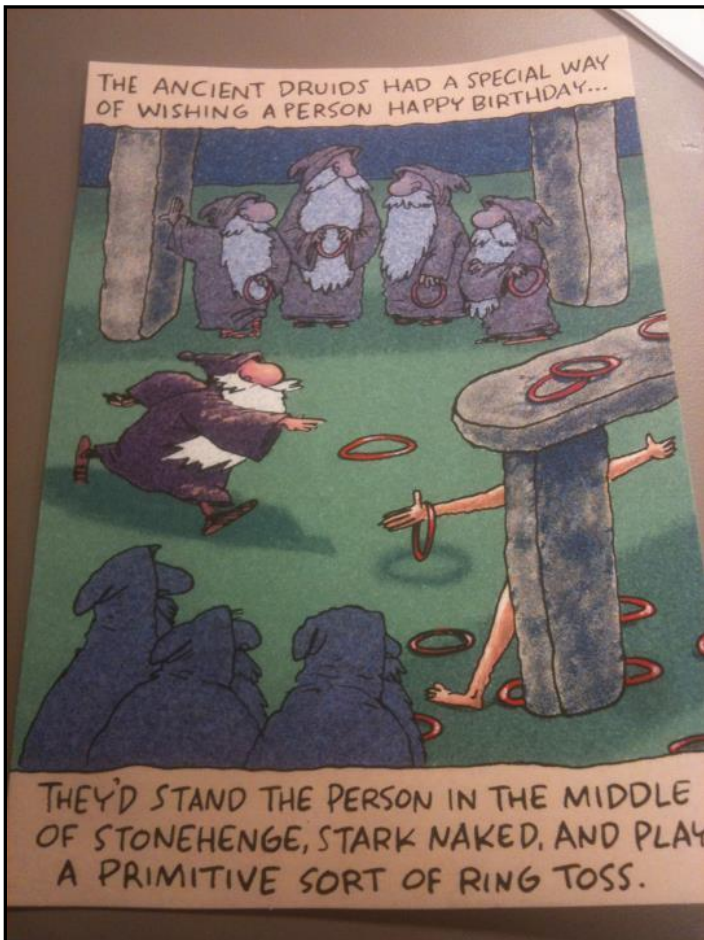

THE ANCIENT DRUIDS HAD A SPECIAL WAY OF WISHING A PERSON HAPPY BIRTHDAY...

THEY'D STAND THE PERSON IN THE MIDDLE OF STONEHENGE, STARK NAKED, AND PLAY A PRIMITIVE SORT OF RING TOSS.

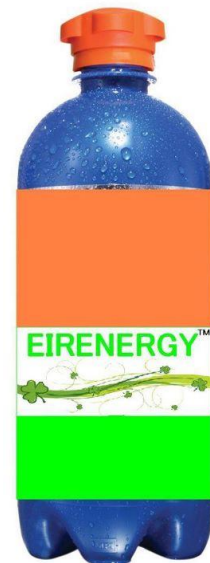

The Irish Energy Drink (besides Guinness)

Mother Gaia by Humon

<http://humon.deviantart.com/art/Mother-Gaia-207388674>

Mother Gaia, I come on behalf of all humans to apologize for destroying nature and beg for forgiveness.

Oh my beloved self-centered humans...



We're sorry for being so selfish. We never meant to kill nature.

That wasn't what I mean by self-centered. Nature is adaptable. No matter what you do to it it will simply change and take on new forms. It has survived worse things than you.

You are however in the process of changing it so much that you can't live in it. You're not killing nature, you're killing yourself.

That's what I mean by self-centered. You think that just because you can't live, then nothing can.



What?

You're fucking yourself over big time and won't be missed.





DESPERATE DRUIDS

If you haven't seen the animated series, go back and take a new look. The first 7 of a projected 40 episodes are done, about 92 minutes total. Another 3 are coming out before Samhain.

Started June 2011. I made 6 Episodes by July as a stand-alone series of lectures. Then I went back and recast them in the style of a dramatic webseries that has the following goals:

-
- Provide a glimpse of how groves operate and deal with festivals, recruiting, training and orientation.
- Put a human face on the many variants of Reformed Druids.
- Follow a new Reformed Druid through a cycle of the year, with developments linked to the season.
- Share the history, customs and stories of Reformed Druidism.
- Give a sense of the humor, timing, and interaction that makes Reformed Druidism special.
- Have an entertaining, intertwined series of sub-plots and story arcs.



**Desperate Druids:
Part 0 Introduction -**
ReformedD... - 269 views

[Desperate Druids: Part 0 Introduction](#)

At the request of a few confused viewers. This "pre-quel" introduces the cast, purpose, scope and aim of the overall series.



**Desperate Druids:
Part 1 - A Walk in the**
ReformedD... - 341 views

[Desperate Druids: Part 1 - A Walk in the Woods](#)

Peter meets the mysterious and lovely Sarah, asks her about Druidism, and gets the basics from her during a walk in the nearby forest .



**Desperate Druids:
Part 2 - The Two Basic**
ReformedD... - 193 views

[Desperate Druids: Part 2 - The Two Basic Tenets](#)

After the previous evening's introduction to the Druids, Peter goes to a coffee house with Sarah on a lazy Sunday afternoon to find out what beliefs bind the Druids together, and have a coffee.



**Desperate Druids:
Part 3 - Less is More**
ReformedD... - 61 views

[Desperate Druids: Part 3 - Less is More](#)

Revised and improved! Peter visits the matronly preceptress, Andrea Chowdhury, of the Jackpine Grove to learn about the rather simple structure of the Reformed Druids, and how many things they lack, compared to mainstream religions and other



**Desperate Druids:
Part 4 - Minds and**
ReformedD... - 48 views

[Desperate Druids Part 4 - Minds and Hearts](#)

Peter encounters Craig, the Celt-crazy romantic bard, as he illustrates his views of Reformed Druidism in the RDNA Jackpine Grove of Ypsalantu University, Michigan. Andrea and Sarah begin a passionate discussion about Andrea's deteriorating situation.



**Desperate Druids:
Part 5 - Celts and**
ReformedD... - 49 views

[DESPERATE DRUIDS: Episode 5 - Celts and Changes –](#)

is ready in the revised musically equipped edition. Andrea's marital difficulties are compounded by developments with her daughter that require some assistance from Sarah. Peter is shocked to learn that some of his lessons are less pertinent than he thought.



**Desperate Druid:
Part 6 - Continuity**
ReformedD... - 36 views

[Desperate Druids: Part 6 - Continuity](#)

Peter learns what Celtic elements were retained by the Reformed Druids and the early changes after Druidism went beyond Carleton. Andrea meets with Jody to work on a continuity planning session for the next academic year at Ypsalantu University and a new recruiting drive.

Then back to all NEW episodes!!! With Episode 7 out before the Equinox when Peter meets the humble and earthy Danny Hamilton, the Geologist (no resemblance to any real person), off in the Spooky Woods, and Andrea consults further with Jody on family issues. Episode 8 & 9 more interactions of the same, plus the introduction of the bizarre Kikki and her even stranger sister Zoe.



THE GREAT DRUID JOKE BOOK

Volume 1
By Mike the FOol

Don't know what came over me, but I started churning out a lot of jokes and grabbing them off the internet. I hope at least a few of them are funny. Please Enjoy.

There once was a smooth-talking Druid
Whose maner of living was luid.
He'd engage Druid lasses
In small talk - no passes,
But the first thing they knew they'd been scruid.

--John Ciardi--

Q: What do you get if you cross a Zen Buddhist with a Druid

A: Someone who worships the tree that is not there.

Q--What do you get when you cross a Zen Buddhist with a Druid mathematician?

A--Someone who worships the square roots of the tree that is not there.

Q--What do you get when you cross a Zen Buddhist with a Druid veterinarian?

A--Someone who worships the bark of the tree that is not there.

Q: What do you get if you cross a Unitarian and a Druid?

A1: someone who can't explain why he's in the woods.

A2: probably frustrated trying to do so

A3: an "x" if they are lying down

A4: nothing noticeably different

SPACE DRUIDS!!!!

NASA sent many many shuttles into orbit circling the earth. They attempted to include passengers of all races, color and creed.. Eventually they invited, a priest, a Druid (as a catch-all) and a rabbi to orbit the earth in the shuttle...

Upon their return, crowds of people formed to hear their religious leaders impressions. First the Catholic priest emerged, beaming and happy, in his white robe. He made a statement regarding how wonderful

it was to visit G-d's creation from space. He said, "It was totally amazing, I saw the sun rise and set, I saw the beautiful oceans. I never knew Asia and Africa were so large! Perhaps, we should send more missionaries?"

Then the Reformed Druid emerged in his white suit also beaming at the peaceful power of creation as view from outer space. He said, "I saw the magnificent earth, our home, I saw the majestic sun. I'm truly in awe. I'm glad to be back with feet firmly planted again on my Goddess. I had to wing a prayer during an eclipse of the Sun and moon by the earth, but it worked okay. The crew enjoyed the whiskey. Oh, and no angels were seen."

Then the Orthodox rabbi came out. He was completely disheveled, his beard was tangled and in every direction, his kappa was frayed, his tallit was wrinkled, like you can't imagine. The crowds asked him, "Rabbi, did you enjoy the flight?... creation?..., outer space?"

The rabbi threw his hands in the air and said, "Vhat "ENJOY??? What was there to enjoy??? Oyoyoy! Three days of continual sunrise and setting! On with the tefillin, off with the tefillin, Mincha, Maariv, Mincha, Maariv!...Gevalt!!!!!!"

The Druids and the Stars

An old Druid and his student are camping on a mountain, set up their tent, and are asleep. Some hours later, The Druid wakes this faithful friend. "Look up at the sky and tell me what you see." The student replies, "I see millions of stars."

"What does that tell you?" asks the Druid. The student ponders for a minute. "Astronomically speaking, it tells me that there are millions of galaxies and potentially billions of planets. Astrologically, it tells me that Saturn is in Leo. Time wise, it appears to be approximately a quarter past three. Theologically, it's evident the Gods are all powerful and we are small and insignificant. Meteorologically, it seems we will have a beautiful day tomorrow. What does it tell you, teacher?"

The Druid is silent for a moment, then speaks. "You idiot, it means someone has stolen our tent!"

LIGHT BULB JOKES

Q: How many Druids does it take to change a light bulb?

A: They don't screw in light bulbs, they screw in Stone Circles.

Q: How many Druids does it take to change a light bulb?

A: Thirteen; one to hold the bulb, and twelve to drink enough to make the room spin.

What's another name for Irish sunblock...?

A pub.

Q: How many ADF druids does it take to change a light bulb?

A: Six. One to change the bulb, one to write a song about how much better the old bulb was, and four to write conflicting parodies of the second Druid's song.

Q: How many Druid's does it take to change a lightbulb?

A: 501. One to change the bulb and 500 to align the new stone.

DEER JOKES

What do you call a deer with no eyes?

No idea

What do you call a deer with no eyes and no legs?

Still no idea.

D'oh! Oh deer, that was not p.c., my fault, the buck stops here, and I apologize, but I'm awful fawn of such jokes, and I rack out a lot of them....

Three Initiations of a Druid Rooky – A Triad

There are three great Hazing rituals, which the divine powers of nature will employ upon the unsuspecting novice:

1)As you are basking in the beauty of the clouds, you trip on a root and fall into mud puddle.

2)While communing with the forest, you fall asleep, only to wake up at night, without a Flash light.

3)Your eye brows are burnt off due to over zealous fire starting.

Reflection: Hey Just because you are a Druid doesn't mean you shouldn't;

1) watch were you're going,

2) take precautions, and

3) use some common sense

CHICKEN JOKES

Why did the RDNA chicken cross the road?

I'll stay on both sides of the road, thank you, very much

Why did the Keltrian chicken cross the road?

Unlike ADF, we're sure it had something to do with the Clannish McNugget

Why did the OBOD chicken cross the road?

What do we mean by chicken, crossing and road?

Let's sit back and think about how the chicken felt, it's motivations and aspirations of chickenhood, then the mystery will be unveiled.

Why did the reconstructionist celtic chicken cross the road?

Chickens are from India, ask more sensible questions, please!

Why did the RDG chicken cross the road?
Come online, we'll discuss it, illustrate it in our next newsletter with some fairies, and include a recipe when you catch it waiting on the other side.

Why did the ADF chicken road?
Well, if you study proto-Indo-European comparative texts you'll see that in Vedic versions...

Why did the Druidic chicken cross the road?
To get to the sacred grove, of course! Keep in mind that 99% of everything written about chickens-crossing-the-road is pure hogwash, based on biased sources. Yes, there were a few unfortunate chicken sacrifices in the past, but that is over now...

Here's the full ADF chicken joke ---- Why did Isaac's Chicken Cross the Road?
P.E.I. Bonewits (ADF): Real crossing-the-road, we have seen, is a very interwoven and complicated subject. Our conclusion could be that real crossing-the-road is the build up of chicken emotion in conjunction with chicken concepts to vary the modulation of chicken energy so as to effect the modulation of the road's energy. That's all! Perhaps it is unfortunate, though, to use the word "chicken" in relation to it, since the "C" word is being used now in a way it was never used before in the English language and is an utterly meaningless term without a qualifying adjective. And this, of course, is the fault of the medieval Christian Church, through the Gothic Chickens it invented and used as the basis of persecuting men, women and chickens. The word "chicken" itself comes from an Indo-European root, "cheeka/e" meaning "one who lays eggs," and it has no relation to the later Anglo-Saxon word for "wise spirit of flight," as so often stated by certain contemporary "Chics." An'Chk'Rrhod ("Our Own Chickens on Our Own Roads"), an authentic Neo-Chicken Rooster tradition, offers the best of paleo-, meso- and neo- Chickenism...

Q: Did you hear about the druid swinger?

A: He was into tree-somes

Q: How do Druids like their whiskey?

A1: very much , thank you.

A2: on the rocks... By the rocks... By the trees... In the breeze....

Q: What do you call a bunch of mad juvenile Celtic warriors?

A: some angry young torcs

Q: Which Sesame Street character do Druids like?

A: Grover

Q: Which character do they like even more?

A: Super-Grover!!!! (and he's cute too!)

Q: How does a Druid multi-task?

A1: poorly

A2: thinks and talks at the same time

A3: "Billy you get the fire started, Samantha you carry the gear up the hill, Moonblossom Ravenfeather make everyone rehearse the Druid Stumble for the liturgical dance, Peter you're fabulous-give us a song, and I have a call of Nature to reply to, be right back!"

Q: How did the Druid feel after building his grove's rock circle?

A: Stone tired

Q: How did the Druid feel when he dropped the sacramental whiskey bottle on the altar before the service ?

A: Stone sober

Q: It is ancient Ireland and an outcast criminal receives a sentence of excommunication and exile and the Druids getup and turn their back on him. Yet the condemned bows and waves with a smile, why?

A: because he had received a standing Ovate shun!

Q: What do you call a Druid who doesn't listen?

A1: quite common

A2: bard of hearing

Q: If the preceptor tries to assizes the divination at an rdna service by farting, what do you call that?

A: The winds of Vates

Q: Why did he preceptor refuse to gather the plant sacrifice anymore ?

A: because she's sickle that job

Q: What do you call the experience of a Druid having visions while performing a sacrifice? (non animal of course)

A: an altared state of consciousness.

Q: and a few bottles later?

A: an altared state of unconsciousness

Q: Why did Druids stop building stone circles?

A1: people had moved on to pentagrams

A2: the copper age and iron age had begun, and the circles kept getting lost

A3: what we stopped?! Must have missed the memo, oh yeah they didn't write

Q: In ancient times why didn't the Druids write books?

A1: because they were illiterate

A2: because they already had all the royalties they needed

Q: Why did the Druid complain to his podiatrist?

A: because he had a case of mistletoe

Q: In ancient Gaul what do you call the idiot who forgets to bring the two white bulls to the midsummer solstice sacrifice?

A: An oxymoron

Q: How do you fire a really bad archdruid?

A: Qait until the elections of Samhain or Beltane, get some kindling, use the whiskey as an accelerant, and....

If Greenland was a nice advertising trick

Finnland is full of Finns

Poland is full of Poles

What about Holland? Seems pretty dry...

Ireland seems fitting though, to read the tabloids and public discourse

Q: What do Druids and squirrels have in common?

A: They both associate with nuts.

I'm a Wiccan-Shaman-Druid

(Tune: I'm a Yankee Doodle Dandy)

I'm a Wiccan-Shaman-Druid,
I am new age through and through.
Decked in crystals from my head to toe,
With feathers and pyramids, too.
My spirit-guide is from Atlantis.
He's a Zen-Aztec guru.
Come and spend the weekend with us,
For two thousand dollars
You'll be a Wiccan-Shaman too.

I'm an Elvis-Loki-Viking.
I channel Ashley Montague.
In a former life I was a gypsy clerk,
Bull fighter, and troubadour, too.
I know five Illuminati,
They're a strange and motley crew.
There's a priest from ancient China,
He lives in my basement.
He is an Elvis-Viking too.

My coven is part Rosicrucian,
Mixed with some Theosophy.
Add in some stuff from the Golden Dawn,
'Cause Crowley's just all right with me.
I've got twelve initiations,
I've seen all there is too see.
And watch out for those strange Co-Mason-Santaria-
Druids,
They'll cement your chickens to a tree.

I've got a pipe ceremony,
Adapted from the O.T.O.
I use a sweatlodge for my Beltane rites,
The Maypole is just there for show.
I have got a glass athame,
With batteries to make it glow.
It's just great for calling quarters
In my new tradition:
The Lynn Andrews-Buckland-Starhawk Grove.

From Domi:

A Witch, dressed all in black, and a Druid, dressed all in White, were sitting at a table in a bar. The Druid was wearing a large button that said "Druids do it in threes". After a couple of drinks a woman at the next table leaned over and asked, "Where is the third one and what color is he or she wearing?"

I hear the Druids didn't like Caesar?
Yes, they thought he had a lot of Gaul!

When some Druids see half a glass of whiskey, they think, "It is half-full." Others glumly conclude, "It's half-empty." But Reformed Druids grab the glass, shoot it down, slam the cup and say, "Huh, hey,... what?" - Isaac Bonewits, 1999.



A Druid, Imam and a Minister walk into a bar

The Christian says one is the number of gods and true faith, which is us, so I'll buy the first round

The Imam says Islam is the second largest faith in the world, but not for long, so I'll buy the second round to console you

The druid say Three is a sacred number to the us, the trinity, and the three holy places of Islam, so I'll buy the third round if you'll both shut up. Why don't you guys get some stones and fix your problems?

QUOTE: An archdruid is defined as the grove member who runs Away from Responsibility the slowest.

BOAT JOKE

During an interfaith picnic, the ministers duck out for some fishing. A Druid, catholic priest And a rabbi are in a rowboat and not having much luck.

the deacon yells something indistinct from the shore from the shore so the priest jumps out and sprints across the water, impressing the other two and runs back to the boat sinking deeper with each step but just makes it back to the gunwhale and vaults back in. He tries to brush off their praise by saying it is just a trick his founder taught thefaithful.

The rabbis wife then yells that he forgot his lunch so he like wise hops across the water and comes back without even wetting his trousers, and notes to the priest that Jesus was Jewish afterall you know, and whispers to the Druid that he earlier saw there were a number of stepping stones under the surface of the water surface going to the shore.

The Druid's beer buddy yells out that the drumming session was about to start. The Druid stands up and says that she learned a thing or three too, leaps off the boAt and quickly disappears into the wAtEr. The other two are laughing when she resurfaces, but is smiling.

"I don't know why you guys are so afraid of immersing your self in nature, the waters are just fine!" and she waves a fish at them.

RIDDLES

Q: What disease do Druids fear the most?

A: Sickle Cell Anemia

Q: What do you call a failed Druid?

A: A celt who can't

Q: What do you call a crazy Druid?

A1: Normal

A2: Unhanged

Q: What do you call a drunk Druid?

A1: Unnoteworthy

A2: Mike

A3: A fluid Druid

A4: Happy

STONEHENGE WATCH HUMOR

Sam: Mike, look I got this commemorative Stonehenge 5000th year sundial watch? Now, I'll always know the time and the equinox!

Mike: But, does it work at night?

Sam: Sure, just use a flashlight.

Celebrate the 5,000th Anniversary of the Construction of Stonehenge, with the New Fifth Millennial Edition

www.prweb.com

The Stonehenge Watch™ is specially crafted to keep the integrity of the original...See More



<http://www.prweb.com/releases/2006/11/prweb478300.htm>

After selling out the inaugural run of the 5th Millennial Edition of the Stonehenge Watch™ -- "A great leap backward in time telling!" The makers of The Stonehenge Watch™ are pleased to announce that it is back in stock and ready to ship. This edition commemorates the 5th Millennium of the construction of Stonehenge.

The Stonehenge Watch™ has garnered much international attention and has been featured in Playboy Magazine, at The International Sky Art Conference at MIT, on BBC-TV, in Astronomy Magazine, in Stuff/UK's 100 Best Gadgets of All-Time issue; featured in Inc. Magazine, is represented in the classic college textbook, Astronomy: From Earth to the Universe (Saunders), and has even been for sale at the Stonehenge site itself.

This 5th millennial edition of the watch is specially crafted to keep the integrity of the original construction of Stonehenge, and thus, when opening the watchcase, can use the built-to-scale model of Stonehenge as a shadow clock to tell time, mark the four seasons and note the passage of the years. Every astronomical function that was intended by the original builders of Stonehenge can be accomplished with the watch.

By owning The Stonehenge Watch™, users will quickly learn that Stonehenge is, at once, the oldest and newest way to tell time. Begin a "Great Leap Backward in Time" by pressing the watch stem button atop the rugged alloy watchcase and witness the mystery of Stonehenge revealed.

Inside, see the exact scale replica of the major components of the 5,000 year-old megalithic monument known as Stonehenge. Orient yourself with the watch's accompanying high viscosity compass to tell local apparent time just as the builders of Stonehenge did thousands of years ago. The late esteemed astronomer, R.J.C Atkinson, former Chairman of the Royal Commission on Ancient and Historical Monuments in Wales, renowned as The Authority on Stonehenge archeology, has called The Stonehenge Watch™ a "Handsome and ingenious time-piece." Catherine Salmons, in The Boston Phoenix has said, "I'm amazed by the cleverness of The Stonehenge Watch, the outrageousness of its humor; it's a three-dimensional Zen conundrum, the ultimate neo-dada gadget." Ivan Peterson, of Science News Online wrote, somewhat tongue-in-cheek, when comparing The Stonehenge Watch™ to a modern day super accurate atomic clock, "The Stonehenge Watch™ tackles the passage of time in a considerably more contemplative manner." Also available with The 5th Millennial edition of The Stonehenge Watch™ is a limited edition signed copy of the outrageously funny, Stonehenge Unraveled, by Peter Payack (Inventor of the watch) which again, R.J.C Atkinson called "a satisfying and scholarly guide to the unique time-piece."

FOR ORDERS, DETAILED INFO, PHOTOS, HISTORY: <http://www.Stonehengewatch.com/> or call Steve Sharpe (Designer, manufacturer) at Sharpe Products (973) 335-8535 or toll free 1-888-Watch-55. CONTACT INFO: Peter Payack, inventor of The Stonehenge Watch™, at (617) 492-2913; 617-512-9196 (cell) or e-mail Payack@aol.com

QUOTES:

ENGADGET.COM: "Apparently the conveniences of modern technology have made us all very lazy. It's just too easy to tell time these days, which is why Sharpe Products is going super-old-school and selling the Stonehenge Watch... this pocketwatch manages the perfect blend of style and street cred for the Druid-on-the-go. It's a throwback to the days before atomic clocks and internet time servers, when estimating the time to within an hour was considered deadly accurate."

LUXURYREVIEWER.COM

Lately, we've seen a ton of innovative new watches that change the way you have to read time. Here's our top 10 of the most innovative watches on the market: 10. Piaget Polo Tourbillon. 9. Luxury Erotic Watches. 8. Scope Watch. 7. The Stonehenge Watch™...

CURIOCITYONLINE:

"If it was good enough for the Druids, isn't it good enough for you?"

ASTRONOMY MAGAZINE:

The great American poet Henry David Thoreau admonished his readers to "simplify, simplify, simplify." If you feel as if you should heed this call, and you have no desire to wind watches or change batteries a traditional solution awaits.... The Stonehenge Watch.

HËNJ

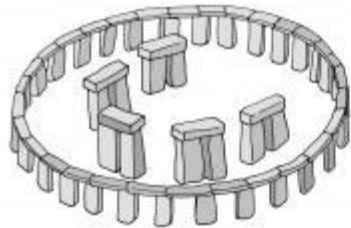

80x



30x



30x



10x

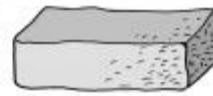

5x



1x



3x

1

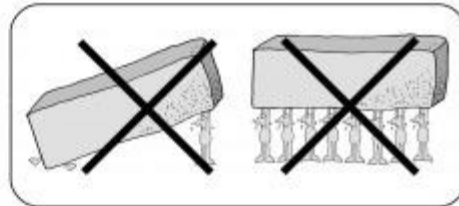

2

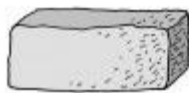
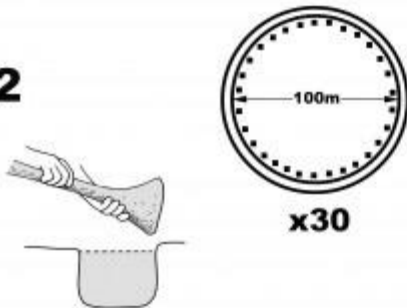

30x

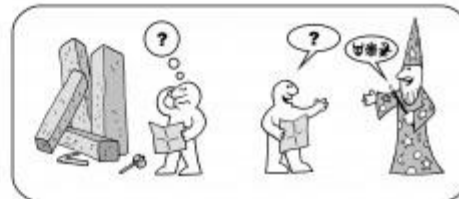
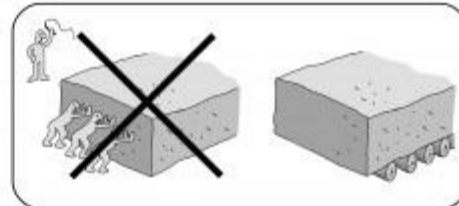

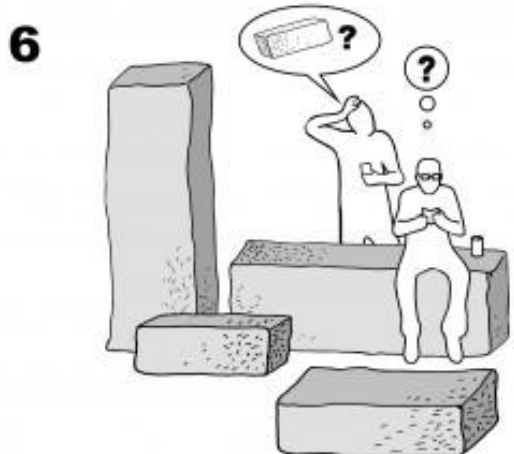
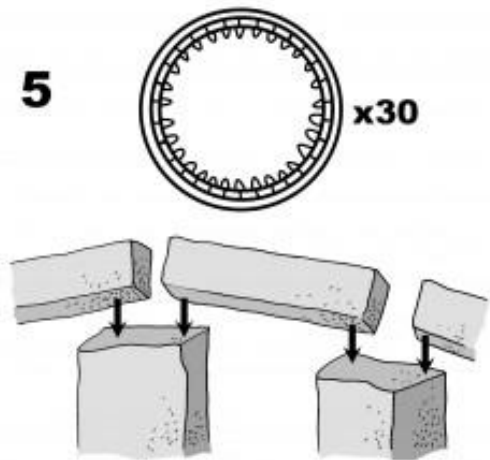
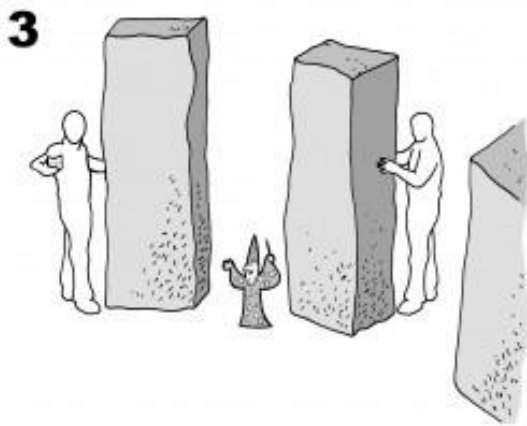

Important! Ensure all components are free from mud, dung and evil spirits before assembly. Wear appropriate safety equipment (spear, flint knife etc.) in the event of bears. Small parts are not included.
If plagued by demons or suffering from pestilence, seek advice from a druid before attempting assembly.
May contain quartz.



Newly Discovered First Page of the Bible

They recently discovered a smaller scroll hidden in the cylinder of the first scroll of the ancient Biblical scriptures, believed to be the actual "first page" of the Bible. When deciphered, it read:

"Copyright (c) 300 B.C. God. All Rights Reserved
First Scrawling: First-Sunrise-After-Stonehenge-
Keystone- Is-Shadowed, 300 B.C.

All beings, places and events depicted in this work are fictional, and any resemblance to actual beings, places and events past, present or future is purely coincidental.

WARNING: Some of the actions performed in this work are dangerous and should only be attempted by professionals familiar with the action in question.

NOTE: Those tiny points of light in the sky when it gets dark are called 'stars.' Some of them do blow up on occasion. In no way should this be construed as a sign that there is, beneath such an explosion, any form of savior. Should such a misconstrual happen, the author will not be held responsible for the avalanche of arrogance, zeal, bigotry, humanocentricity and other vile acts which will surely follow the residents of the planet into time eternal until someone sees fit to erase the denizens of the world and let the author start over.

ISBN 0-000000-0000-1

Suggested retail: 1 sheep."

IF THE APOSTLE PAUL HAD SENT HIS EPISTLES BY E-MAIL..."

From: Glenn McDavid gmcdavid@winternet.com

Found on an ancient clay floppy disk:

Subject: The Third E-mail to the Corinthians
Date: 24/03/65 21:07:33 ROMAN standard time
From: Apostle Paul (paulorsaul@theapostles.org)
To: congregation@corinth.org
File: Epistle3.txt (104201 bytes)

[Only the first part of this message is displayed. The entire message has been turned into a text attachment, encoded in 128-bit MIME and can only be read if you have an obscure program that you won't have heard of.]

Paul, an apostle of Christ and a slave of the Lord, to the brothers in Corinth who are using e-mail accounts other than AOL. I will send a separate message to those using AOL accounts, knowing how primitive their e-mail service is at the present time.

This is the third e-mail I am sending to you. Did you receive my other two? I have had no reply from you yet, and a "fatal delivery" error message for the second e-mail, in which I wrote about love, faith and hope. I will send it again, just in case.

I sent my second message to the congregations throughout the whole of Asia Minor, but my service provider considered this to be spamming and closed down one of my accounts. To those who are using Web based e-mail accounts, I will send Timothy to you with my message on foot. It will get there quicker.

Philemon and Titus send you their love. I found their e-mails amidst a flood of junk mail and get-rich-quick messages, in which there is no real profit. Look - I hope you don't mind, but I think I'll stick with the parchments next time.

Anyway, I wanted to write to you on the important subject of..

{End of Message}

We Move Big Rocks!

(Queen- We Will Rock you!)

[http://youtu.be/ P01zCnPI2A](http://youtu.be/P01zCnPI2A)

Laddy you're a young man strong man
Shoutin' at the line gonna raise the top stone this
day
You got sweat on yo' robe
Steady the rope
Spreadin' your circles all over the globe

We move we move big rocks
(sound effects: stomp stomp clap ...)
We move we move big rocks
(sound effects: stomp stomp clap ..)

Laddy you're an old man wise man
Sightin' with your stones gonna chart all the stars
some day
You got salt in your beard
The clouds have cleared
It all makes sense what once was weird.

We move we move big rocks
(sound effects: stomp stomp clap ..)
We move we move big rocks
(sound effects: stomp stomp clap ...)

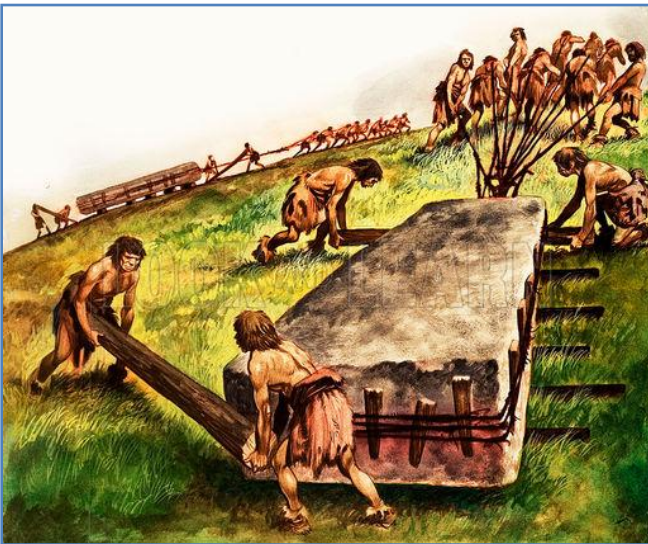

I Wanna rock!

(original by Twisted sister)

[http://www.youtube.com/watch?v=ST72iBLepT
w](http://www.youtube.com/watch?v=ST72iBLepTw)

I wanna rock! (Rock)
I wanna rock! (Rock)
I want this rock! (Rock)
I wanna rock! (Rock)

Just use wood they say,
Well all I got to say to them is time again I say,
"No!"

No! No, No, No, No, No!

Tell me choose light stuff

Well, all I got to say to them when they tell me
choose light stuff, I say, "No!"

No! No, No, No, No, No!

So, if you ask me why I like hauling the big
stones

There's only one thing I can say to you

I wanna rock! (Rock)
I wanna rock! (Rock)
I want this rock! (Rock)
I wanna rock! (Rock)

There's a feelin' that
I get from nothin' else and there ain't nothin' in the
world

That lasts so long! Long! Long, long long, long!
Stores the power up

I've prepared for so long so I could have my very
own dolmen, so Let's pull!

Pull! Pull, pull, pull, pull, pull!

When it's this big I feel the backpains shootin'
through me

There's nothin' else that I would rather do!

I wanna rock! (Rock)
I wanna rock! (Rock)
I want this rock! (Rock)
I wanna rock! (Rock)
Paper Rock Scissors for Overachievers

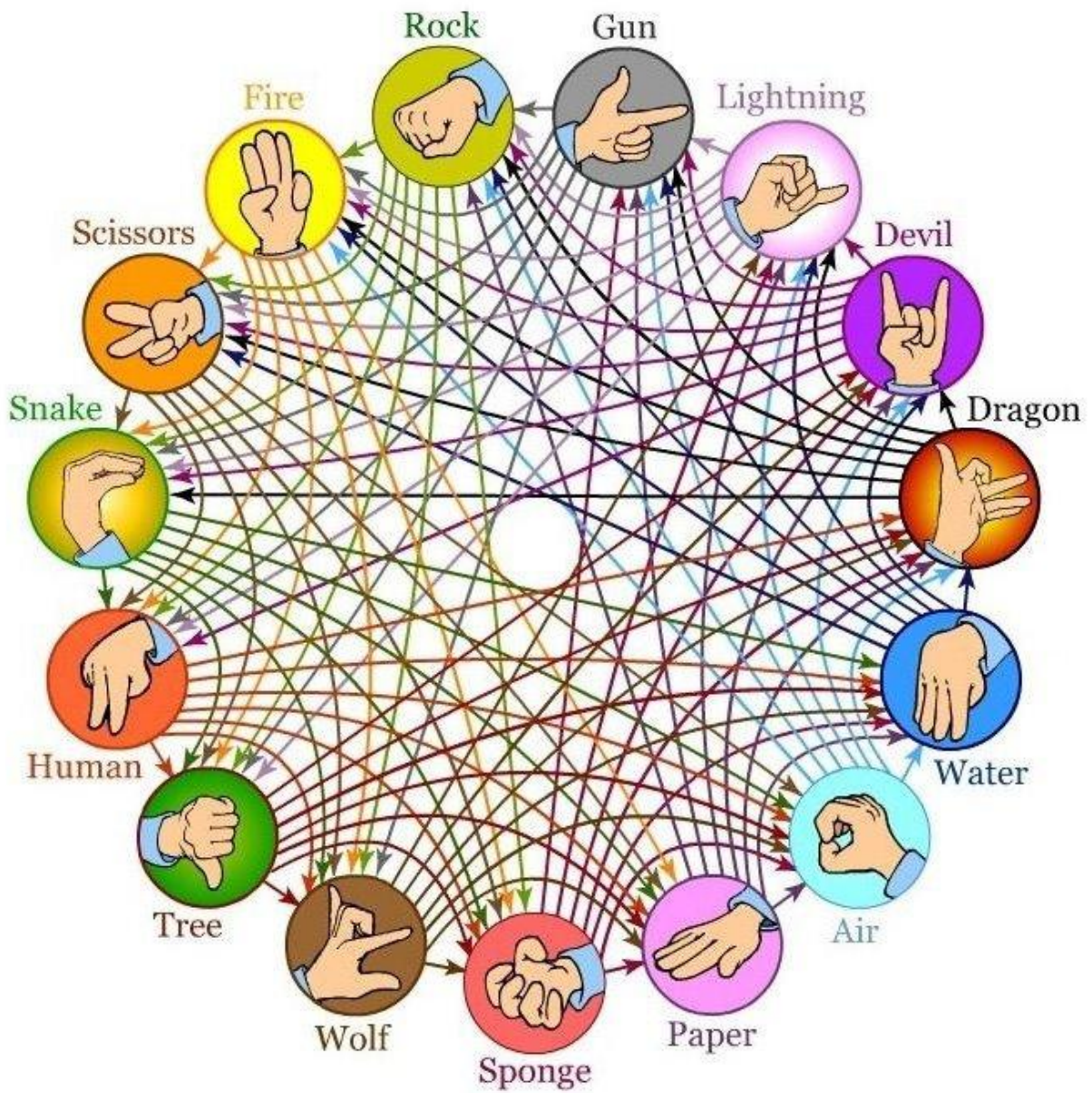

Paper Rock Scissors for the Overachiever

CRAFT CORNER

What is Art Clay Silver & what's in it?

http://www.artclayworld.com/what_is_art_clay.php

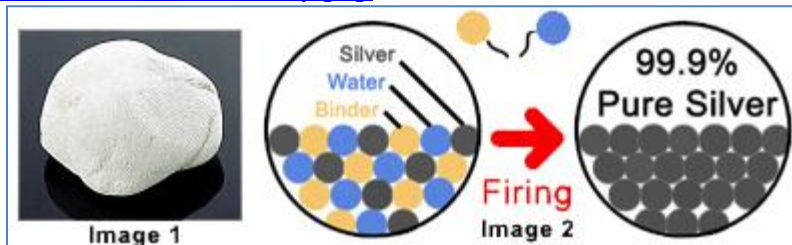

When Art Clay Silver is taken out of the package, it is a slightly moist lump of clay (Image 1). The clay is composed of 1-20 micron sized silver particles, organic binders, and water. The clay is then molded into its desired generic shape, and dried. Once the clay is completely dry it can then be filed, carved, and sanded; after which it is fired with a gas stovetop, butane torch, or kiln.

During the firing process, the organic binders burn away and the resulting silver particles "[sinter](#)", becoming denser and stronger (Image 2). The burning away of binders and sintering of metal causes the piece to shrink 8-10% in overall size while retaining the original form. Once completely fired, the remaining piece is composed of 99.9% pure silver.

Examples of the three different firing methods:



What is the difference between Sterling Silver and Pure Silver?

Sterling Silver is composed of 92.5% silver and 7.5% of one or more other metals. A common misconception is that copper always makes up the remainder, when in reality titanium, platinum, palladium, and a list of other metals are often used. The addition of another metal to the silver creates an alloy. Sterling Silver is stronger than Pure Silver, and as an alloy, it tarnishes more quickly as well. Pure Silver is composed of 99.9% silver and nothing else.

[Fired Art Clay - Mirror Finish](#)

[Solid Silver](#)

These two slides compare Art Clay Silver, finished with a perfect mirror shine, to a piece of Solid Silver. Magnification 2100 times. Note the similarity and the fine surface of the Art Clay.

Is Art Clay safe to use?

Yes, all but one of Art Clay's products are non-toxic, and most carry the ACMI "AP" seal.

The manufacturer of Art Clay, Aida Chemical Industries, Co., Ltd. is a member of the Art & Creative Materials Institute. The Art & Creative Materials Institute, Inc. is an international association composed of a diverse and involved membership, and is recognized as the leading authority on art and creative materials. ACMI's members are art and creative materials manufacturers, and currently there are over 210 members. Since its inception, ACMI's certification program has certified that products in the program are either non-toxic or appropriately labeled with any cautionary language and safe use instructions. Of the 60,000 art materials in the program, 100% of the children's products and 85% of those meant for the adult artist are certified as non-toxic. This certification program has received the endorsement of experts in the field of toxicology and is one of the finest industry programs in existence. ACMI seeks to create and maintain a

positive environment for art and creative materials usage; to promote safety in art and creative materials; and to serve as an information and service resource on art and creative materials.

What do the ACMI Seals mean?

The AP (Approved Product) Seal, with or without Performance Certification, identifies art materials that are safe and that are certified in a toxicological evaluation by a medical expert to contain no materials in sufficient quantities to be toxic or injurious to humans, including children, or to cause acute or chronic health problems. Additionally, products bearing the AP Seal with Performance Certification or the CP Seal are certified to meet specific requirements of material, workmanship, working qualities, and color developed by ACMI and others through recognized standards organizations, such as the American National Standards Institute (ANSI) and the American Society for Testing and Materials (ASTM).

Who makes Art Clay?



Art Clay is manufactured in Japan by [Aida Chemical Industries](#). Aida Chemical Industries is a family owned company that recycles and reclaims metals, including the precious metals gold and silver. In 1991 Aida Research and Development obtained a patent for the manufacturing process for a metal clay, which became Art Clay. The clay, paste and syringe types were introduced to Japan in late 1992. The Aida Planning Department began to develop the books and other accompanying materials and, in April, 1994, Art Clay Silver and Gold were officially introduced into the general public in Japan. Art Clay World, USA is the North American distributor of Art Clay, and you can [click here](#) for a list of links to other worldwide distributors.

Aida Chemical Industries is a "green" company. It collects metals which already have been used and reclaims these metals. Such items as computer circuit boards and silver from photographic supplies are processed in tremendous quantities every year. A portion of this harvest becomes Art Clay Silver and Art Clay Gold.

Aida combines these reclaimed metals with non-toxic, organic binders. The result is a product which can be handled safely. Every effort has been made to assure the safety of artists using Art Clay. Even the production processes used to create Art Clay are designed to have minimal effects on the environment.



FALL SONG SELECTION, Part One
By Mike the Fool, mikerdna@hotmail.com

I am putting together a song book and hope to release it over the next few weeks and I'm looking for suggestion from you to fill out the pages.

Some songs are already in my master collection, just have to pull them out for seasonal use.

Anything for balance - leaves- changes- falling - nuts - bones - monsters - death - witches - pumpkins - spooky- eating - turkeys.

Quite a lot to work with.

Farming Songs:

Jimmy Crack Corn
Oat, Peas, Corn and Barley
Old MacDonald
I am an Acorn
Farmer in the Dell
Little Boy Blue
Field Behind the Ploy
Home Again
Country Roads

Death Themed:

Cat came back
Dem Dry Bones,
With Her Head Tucked
Ship Tlatnic,
Music Alone Shall Live,
Ghost of John,
Hey Ho Nobody Home,
Minstrel Boy,
The Fox,
Grandfather's Clock,
Found a Peanut,

Fiddlers Green,
Bash the Balrog,
Bright Side of Life,
Irish Ballad,
Black Widows in the Privy
Night Paddy Murphy Died,
Little Bunny Foo foo,
Two Sisters
Two Brothers
Well Below the Valley
Green Grows the Grass
Trees Grow High
Burden of the Crown
Danny Boy
Barbara Allen
Ash Grove,
Where have all the flowers gone,
Banks of the Ohio,
Outlandish Knight
Lord Randall
Lord Franklin
Skye Boat Song
Wayfaring Stranger

Streets of Loreda
Reward of Virtue (Sir Gilbert)
Monster Lullaby
Stones of Orkney
Willie McBride
Farewell Nova Scotia

Time & Seasons Changing

Turn Turn Turn
Circle Game,
Turning toward the morning
Brandy Tree
Puff the Magic Dragon
When I'm 64
Hearth and Fire
Blowing in the Wind
Today

Magic Themed

Witch West Moreland
Karelia's Song,
Great Silkie
13 Days of Halloween

NEWS



Scientists Trace Heat Wave To Massive Star At Center Of Solar System

AUGUST 8, 2011 | ISSUE 47•32

According to scientists, the large star could be described as a tremendous ball of energy.

-Onion News

• PASADENA, CA—Groundbreaking new findings announced Monday suggest the record-

setting heat wave plaguing much of the United States may be due to radiation emitted from an enormous star located in the center of the solar system.

Scientists believe the star, which they have named G2V65, may in fact be the same bright yellow orb seen arcing over the sky day after day, and given its extreme heat and proximity to Earth, it is likely not only to have caused the heat wave, but to be responsible for every warm day in human history.

"Our measurements indicate the massive amount of energy this thing gives off is able to travel 93 million miles and reach our planet in as little as eight and a half minutes," said Professor Mitch Kivens, an astronomer at the California Institute of Technology. "While we can't see them, we're fairly certain these infrared rays strike Earth's surface, become trapped by the atmosphere, and just heat everything up like a great big oven."



"We originally thought that if this star was producing temperatures of 100-plus in the South and Midwest, it must be at least 100 degrees itself," Kivens added. "But it turns out it's far, far hotter than that, with a surface temperature of nearly 10,900 degrees Fahrenheit."

Kivens and his CalTech colleagues said this intense radiation, which results from constant nuclear reactions converting hydrogen to helium in the star's core, could also account for why the orb in the sky is extremely bright and difficult to stare at directly.

While scientists initially assumed the heat and luminescence of the star must make it the largest in the universe—a theory lent credence by the star appearing much bigger than other objects in the sky—they said the data actually appear to refute such a notion.

"Apparently it's gigantic simply because it's closer to us than any other star," Kivens said. "Which would also account for why we feel this particular star's heat during the day but are not warmed by the tiny blinking stars we see at night."

"It's interesting stuff," he added.

According to Kivens, the discovery has prompted researchers to explore the possibility that a variety of phenomena accompanying the heat wave could also be linked to the star, including taller grass, hot car seats, red skin burns, and sweating "even when one has just been standing there and hasn't been running around or anything."

An additional study is reportedly being conducted to determine if the unexplained shrinking of puddles until they disappear may be caused by star-hotness soaking up all the loose water. Moreover, scientists reportedly believe the heat emitted from the glowing orb could potentially be the reason why it is uncomfortable to walk on asphalt barefoot.

When asked if anything could be done to prevent or counteract the star's heat production, Kivens expressed skepticism.

"No, for the foreseeable future, I think we're locked into orbit with this thing," he said. "Although the star seems to disappear every night, 24-hour reports from around the world seem to indicate the star never leaves Earth entirely."

Residents of heat- and drought-stricken regions welcomed the findings, thankful to finally have an explanation for the high temperatures, if no relief from them.

"That makes sense, because it's usually hotter when that [star] is up in the air," said Stillwater, OK resident Asher Arps, 31, speaking to reporters as temperature rose to 110 degrees over the weekend. "I knew it lit things up, of course, but I didn't realize it could make things hot."

"The big star heats the earth, and the moon cools it—I get it," he added.

As to potential applications of the new discovery, experts acknowledge the possibilities could be limitless. "This is a watershed moment," renewable energy specialist Dr. Martin Flint said. "Who knows where this could lead? Perhaps we could develop a method of harnessing these big star rays and transforming them into some sort of ecologically friendly power source."

"Wait, what am I saying?" he said, laughing. "I'm getting ahead of myself. We still don't understand how it's possible for that thing to be up in the sky in January when it's freezing outside." 🌱

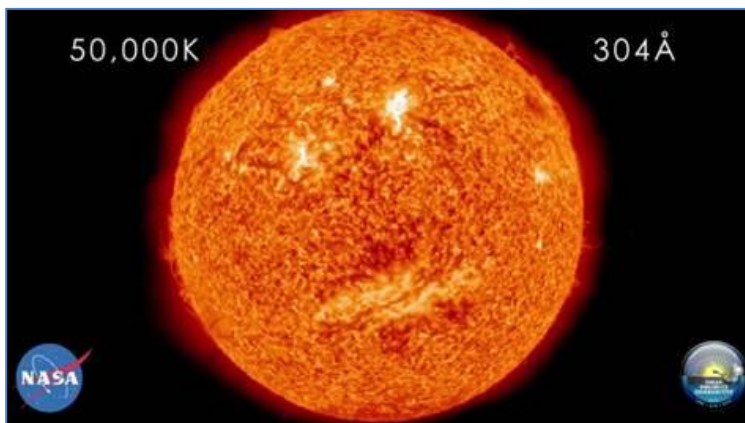

SUN IS SMILING!

Our sun is apparently a happy star, according to the latest video from a NASA observatory. The video shows a pattern of sunspots that, when viewed from afar, forms a vast happy face smiling across face of the sun.

[Sunspots are darker, cooler patches](#) on the sun caused when intense magnetic activity blocks

heat convection. These spots are normal, but they don't usually align to give the sun's face such character.

The smile on the sun is visible through 11 photographs taken by NASA's Solar Dynamics Observatory, which images the sun from Earth orbit. Each picture was taken at the same time, but through a different filter that separated out a narrow wavelength band of light. The images range from lowest temperature to highest.

These different temperatures correspond to different layers of the sun's atmosphere, starting with the sun's surface and gradually moving out to the sun's upper corona.



SLAVIC DEITY FOUND IN RIVER

[Watch](#) 

Divers find wooden sculpture of pagan deity at bottom of Drissa River in Rossony District in Belarus.

This is the first such discovery in the Eastern Europe. The oak sculpture has well remained, - its eye-sockets, mouth and chin are accurately visible. It weighs about 200kg, the height is 122cm, and the width in the bottom basis is more than 1m. According to preliminary data, the sculpture dates back to the late 12th century. According to scientists, the idol may represent Perun or Veles. The sculpture was sent for research to the Institute of History of the Academy of Sciences of Belarus. After restoration and preservation the curiosity will take a place of honor in the institute exposition.

Quote: “The Water is Great! Come on in!”



Prehistoric Irish Landscape Beneath Ocean

LORNA SIGGINS, Western Correspondent

Thu, Aug 11, 2011

<http://www.irishtimes.com/newspaper/ireland/2011/0811/1224302231151.html#.TkOUVwiD7bI.facebook>

A RARE artefact that was tangled in seaweed attached to lobster pots may indicate the presence of a submerged prehistoric landscape off the north Connemara coast.

The flint core or scraper is “almost certainly” from a submerged site near Lettergesh, according to archaeologist Michael Gibbons.

“It is difficult to date precisely, but is likely to be 4,000 to 6,000 years old,” Mr Gibbons says.

The flint core, located in the lobster pot string by David Coyne, could have been used as a large scraper to clean hides or skin.

“The sea level rise on the Galway coast may have been by as much as 10 metres since the first people settled here almost 10,000 years ago, and this discovery suggests that this rare find is just the tip of the iceberg,” Mr Gibbons says.

Several submerged landscapes have been located by archaeologists along the west coast. The remains of a midden site farther along the coast at Tullybeg were dated to between 6,000 and 7,000 years back by a team from Queen’s University Belfast, he points out.

A flint arrowhead also recently located on Inishbofin off the Galway coast is the fifth such artefact to be associated with one area – the island’s west quarter.

The arrowhead is early Bronze Age, which Mr Gibbons describes as “one of the finest ever to be found on Ireland’s west coast, and is a classic museum piece”.

“It was picked up by an American visitor while on a field trip to the island,” he says. “The fact that it is one of five finds from this area suggests west quarter was an important hunting ground 4,500 years ago.”

The new addition also makes it the largest collection of arrowheads from one single location in Co Galway, Mr Gibbons notes.



“They were all located in an eroding bog, which may have been a fresh-water lagoon in later prehistory, attracting large amounts of fowl. A smaller arrowhead, black in colour, was found close by earlier in the summer.”

The finds, he adds, are further proof of the “exceptionally rich” Bronze Age archaeology on the Connemara islands, including Inishbofin and Inishark, with many houses, field systems, cooking sites and enclosures identified there.

“People were drawn to the islands, perhaps for their rich deposits of soapstone and safe natural harbours.” A separate recent discovery – a polished stone axe picked up in Joyce country near Connemara – yields “crucial evidence” of an early farming community living in the high mountain valley system overlooking the Mask and Corrib lakes, Mr Gibbons says.

“There are far fewer Neolithic sites in this area compared to north and west Connemara, but there are a number of spectacularly located hill-top tombs crowning the hills,” Mr Gibbons says.

Taken together, the artefacts provide “further clues to Connemara’s long and varied settlement history”.



DESECRATION

WHAT PART OF SACRED DON'T YOU UNDERSTAND?

<http://www.youtube.com/watch?v=ynciqY5c3jq>

http://www.youtube.com/watch?v=9e4EETI_1jQ

Let me introduce myself, my name is Theo van Rossum and I'm a human rights activist for Native Americans.

In their struggle for preservation of their sacred sites Native Americans far too often face the problem that people and especially authorities do not understand why mountains can be sacred. I am now especially writing to Pagan people because after having been hanging out with Wiccans for a few years myself I know that you Pagans will have a far better understanding of this, as you also have your specific sacred sites

in Nature be it most of them in Europe like Stonehenge and Avebury Circle and also understand the concept of Mother Earth, that the majority of Christians cannot seem to grasp. Not only the environment in Arizona is at stake now, but also the very survival of a unique native American culture, a culture that already has been subject to destruction before, seeing the era of Indian schools and Christian abuse on Indian reservations.